

self-build solutions

# One system, *infinite possibilities.*

The next generation of trade show and advertising displays is here.



**ISOframe**  
ripple



**ISOframe**  
wave



**ISOframe**  
fabric



**ISOframe**  
express



**ISOframe**  
isobar

**Mark  
Bric**  
Display

**ISOframe**  
Intelligent Exhibiting™



### RIPPLE

Sophisticated alternatives to traditional pop-ups and banner-stands.

{ page 04 }



### WAVE

The world's first fully flexible exhibition displays.

{ page 08 }



### WAVE PREMIUM

The best custom modular exhibits on the market.

{ page 12 }



### FABRIC

Large exhibition walls with gorgeous, seamless graphics.

{ page 16 }



## Behold the future of displays

Striking, flexible, portable and affordable, ISOframe offers the perfect self-build trade show booth designs.

All ISOframe exhibits feature elegant engineering, gorgeous graphics and tools-free setup. Plus, they can link together to form the most adaptable, customizable exhibit displays on the market.

From single banner stands to large-scale exhibits, discover how our next-generation display system brings brands to life — beautifully.



### EXPRESS

Swift, simple options when flexibility isn't your priority.

{ page 20 }



### ISOBAR

Portable, freestanding counters that grab attention.

{ page 22 }



### LIGHTBOX

Stunning, backlit stand-designs that make your display pop.

{ page 24 }



### MARK BRIC PRODUCTS

More exhibit options from Mark Bric Display

{ page 25 }

NEW FOR 2015!



# ISOframe<sup>®</sup> ripple

Lightweight, bendable, portable.

Flexible and extremely cost effective, the ISOframe Ripple will literally change the shape of your exhibition display or retail space.

Ripple supports double-sided graphics and is our most affordable option.

Ideal floor size: 10×10 and up.





Make a straight wall look great.



Add curves to your 10 foot booth.



Use one panel as a kiosk. Add panels to make a full display.



Bend your graphics any way you like.



Scale up or down as your needs change.



Use your carrying case as a podium.

## From Carrying Case to Counter Space



Carry the case with ease.



Attach the counter top.

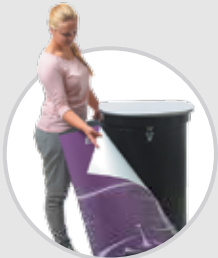

Connect graphic to complete the counter.



NEW FOR 2015!

## ISOframe Ripple. The ultimate linking banner-stand system you can flex to fit any venue.

Need a traditional banner-stand for one event and a pop-up display for another? With ISOframe Ripple, you always have the option you want.

ISOframe Ripple gives you the freedom to flex your display into almost any shape you want — and reduce or enlarge to suit your needs. Use individual banner stands one day. Link them together to create a bendable display the next. Reposition and reconfigure at a moment's notice.

Attractive and flexible, Ripple transports easily and requires zero tools for setup. The carrying case even transforms into counter space. And with accessories like a media screens and spotlights, Ripple gives you the most convenient trade show display on the market.

No matter how you shape and use your ISOframe Ripple, you'll enjoy a seamless, contemporary and portable trade show display that's sure to impress your customers — and your competitors.

## Key Features



**Flex Technology**  
Bends to almost any shape



**2 in 1 Graphics**  
Displays single- or double-sided graphics



**Shape Shifting**  
Reconfigures easily and instantly



**Economical Pricing**  
Costs at least 10% less than the competition



**Portable Design**  
Ships through UPS or FedEx



**Counter Space**  
Transforms carrying case into counter space



**Free 3-D Rendering**  
Includes 3-D display design



**Tools-Free Assembly**  
Simplifies setup with no tools or pros needed

## Tools-Free Assembly in Five Quick Steps



1) Connect post to base support with FASTclamp.



2) Click in base beam.



3) Clip in top beam.



4) Insert top section.



5) Attach graphics with magnetic assistance.

## Engineered for Versatility



Single-panel solutions



Multi-panel solutions

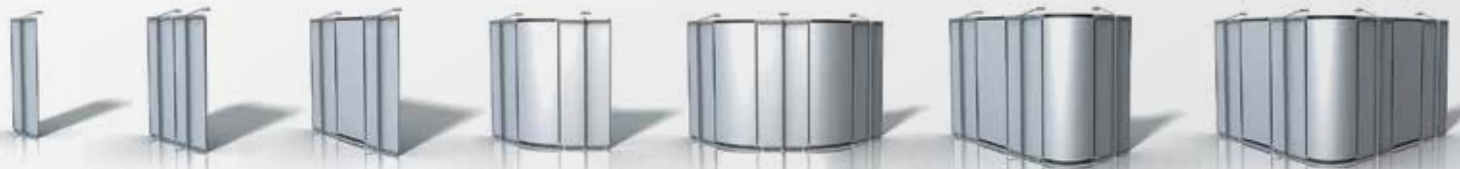

**Mark  
Bric**<sup>®</sup>  
Display

# **ISOframe**<sup>®</sup> **wave**

Flexible, expandable,  
accessory filled.

Stunning looks and elegant  
designs come together to create  
the first portable display system  
that flexes into any shape.

As our most versatile and bendable  
option, ISOframe Wave supports an  
array of accessories and structures.

Ideal floor size: 10×20 and up







Impress with beautiful, seamless graphics.



Fill huge sales showrooms with long-lasting displays.



Reinvigorate retail with LED-lit recessed shelving.



Exercise your imagination with different shapes, accessories and more.



Add monitors and architectural features.



Enjoy local service and support — in 70 countries.

## Key Features



**Flexi-Link Technology**  
Every panel bends up to 180 degrees



**Accessories Galore**  
Holds shelves, showcases, doors and more



**Shape Shifting**  
Reconfigures easily and instantly



**Infinite Adaptability**  
Works again and again and again



**Portable Design**  
Ships through UPS or FedEx



**Counter Space**  
Transforms carrying case into counter space



**Free 3-D Rendering**  
Includes 3-D display design



**Tools-Free Assembly**  
Simplifies setup with no tools or pros needed

**ISOframe Wave.** Create any design you want with the world's first fully flexible display system.

## Tools-Free Assembly in Six Quick Steps



1) Connect base post to support feet using FASTclamp.



2) Slide Flexi-Link into the posts and shape your Wave.



3) Add extension posts to the full height.

## Customize Your Wave With the Industry's Best Accessories

Imagine the wildest shape you can create for a trade-show display. ISOframe Wave can fit that idea — and quickly transform into another stunning design.

Thanks to our patented Flexi-Wave link, each panel is strong and flexible, so you can create amazing convention displays. Flex your entire graphic wall to maximize each event, then extend or reduce your display without reprinting graphics.

ISOframe Wave will twist your idea of what a trade-show booth can be. The only constraints are your imagination.



Table module solutions



Shelf module



Semicircle module



Wave with door



Store room



4) Attach the automatically aligning graphics.



5) Add lights, TVs, tables and more.



6) Complete your stand.



# **ISOframe**<sup>®</sup> *wave premium*

Striking, sturdy, adaptable.

Enjoy a custom-built look and modular function with our grandest trade show exhibits.

Wave Premium is perfect for large displays, high-traffic spaces and experienced self-build exhibitors.

Ideal for any floor size





See why Mont Blanc chose us for a 45-foot, high-traffic display.



Capture attention with large monitors and double-sided graphics.



Create a private room with curves or straight lines.



Demand the durability and sophistication that premium brands expect.



Combine Wave, Fabric, ISObar and more for one cohesive, compelling display.

“ We finished putting together the display, and my customer absolutely loves it! What really sold them is the flexibility of using three panels, all eight, or a combination of something in between and being able to shape it to fit their space. It is really easy to set up, dismantle, pack up and transport. ”

Brianna Palitto  
Eyedeal Graphics

## ISOframe Wave Premium. Self-built trade show displays have never offered more.

With large sizes, strong panels and multiple accessories, Wave Premium screams custom, professionally built exhibit display. In reality, you have the best modular product on the market.

With Wave Premium, you can build almost any display imaginable. From private meeting and storage rooms to bridges connecting separate

sections, this ISOframe fits the most demanding specifications. And its internal framework is strong enough to withstand the most demanding settings.

If you're searching for an impressive, easy-to-assemble exhibit — that you can reconfigure for multiple events — Wave Premium is your new secret weapon.

## Straightforward Assembly With the Patented FASTClamp



1) Open the FASTClamp.

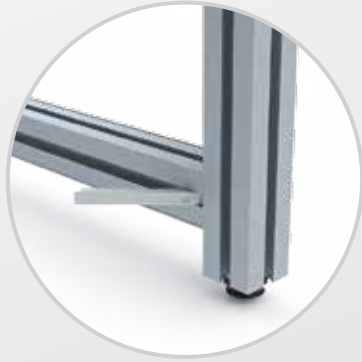

2) Insert into the post.



3) Close the FASTClamp.

## Elegant Engineering Comes Standard

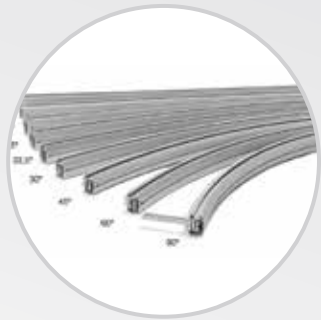

Beams are available with arcs from 0 to 90 degrees.



Curved beams attach quickly with the FASTClamp.



The posts' rounded corners add architectural interest.



Graphics install easily with the intelligent alignment system.

## Key Features



Custom Look  
Combines semi-rigid graphics with sophisticated designs



Large Size  
Stands as tall as 14 feet high



Featured Accessories  
Supports bridges, ceilings, shelving and beyond



2 in 1 Graphics  
Displays single- or double-sided graphics



Sturdy Construction  
Handles heavy traffic and use



Private Areas  
Offers meeting rooms, storage and more



Free 3-D Rendering  
Includes 3-D display design



Tools-Free Assembly  
Simplifies setup with no tools or pros needed



# ISOframe<sup>®</sup> fabric

Sophisticated, simple,  
lightweight.

Impress with the luxurious look  
of fabric — and set up your  
display booth 15 times faster  
than conventional tension  
fabric frameworks.

Fabric supports stunning graphics  
across huge expanses and is our  
most lightweight option.

Ideal for any floor size







Add ceilings, towers and other architectural features.



Customize your display with monitors, floating shelves and walls, and more.



Store goods or host meetings in your private room.



Wrap your entire 10 x 10 space in a graphic.



Dress up your retail corner with graphics on every angle.



Cover large expanses with one unbroken graphic.

“ We couldn't have asked for a better Trade Show booth planning experience. Seeing first-hand how every detail from the sales department to the designers to the actual workmanship of the hardware and graphics was perfectly executed, I was just blown away!

We would definitely recommend Mark Bric Display to other businesses given the awesomely positive experience we've had. You not only built for us a striking and impressive display but you also showed us how a professional company should treat their customers! Thank you!

”

Sam Thatte  
Sam Thatte Visual Communications

## ISOframe Fabric. Create a standout display with gorgeous, seamless graphics.

You can't deny: There's just something special about fabric exhibits. Like art on a canvas, fabric displays are sophisticated and alluring.

But looking good isn't enough. Your exhibit needs to work well, too.

With ISOframe Fabric, we combine state-of-the-art printing, an elegantly engineered framework and silicone-edged fabric to create some of the most

stunning — and functional — trade show displays you've ever seen.

Create huge, seamless graphics. Attach media screens and literature holders to suit your design. Build any size wall you need.

No matter how you use your display, you'll build your brand with ISOframe Fabric's undeniable ease and beauty.

## Key Features



Silicone-Edged Fabric  
Glides into the framework  
for amazingly simple setup



Seamless Displays  
Streamlines your exhibit  
with one flawless image



Gorgeous Graphics  
Features the unique beauty  
of well-printed fabric



Size Flexibility  
Works for everything from  
small displays to 100-foot walls



Extreme Portability  
Packs down into our  
smallest, lightest cases



No Leveling  
Sets up perfectly,  
even on uneven floors



Free 3-D Rendering  
Includes 3-D display design



Tools-Free Assembly  
Simplifies setup with  
no tools or pros needed

## Tools-Free Assembly in Six Quick Steps



1) Connect the base support  
to the frame.



2) Attach two  
L-plate connectors.



3) Secure the second post with  
the FASTclamp.



4) Extend posts by clamping  
them together.



5) Attach frames at the corner  
to create 90-degree shapes.



6) Slide the fabric's silicone edge  
into the frame's channel.



# ISOframe<sup>®</sup> express

Swift, straightforward, customized.

Enjoy speed, simplicity and stability when you're pressed for time. Our modular pop-up system's strong frame means graphics hang perfectly and heavy accessories attach easily.

Express supports customized designs and is our slimmest, quickest-to-assemble option.

Ideal floor size: 10x10 and up



Set up your display in seconds.



The multi compartment case protects your graphics and comes standard.



Setup is quick and simple.



Feature graphics on your display's flat ends.



Add tables, monitors and other accessories.

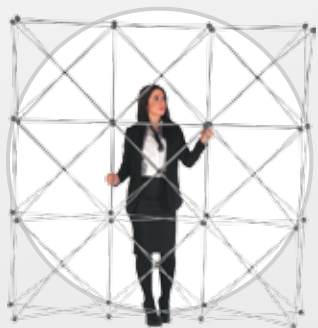

The cross-braced frame makes Express very solid on any floor.



Graphics self-align with magnets.



See why international brands choose Express as a backdrop for business.



Transform your carrying case into a podium.

## Key Features



Pop Up Frame  
Sets up quickly and easily



Customized Designs  
Fits your needs with  
built-to-order shapes and sizes



Impressive Strength  
Features amazing stability thanks  
to the cross-braced frame



Slim Design  
Saves floor space with our  
smallest [dimensions] frame

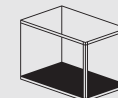

Frame Engineering  
Ensures graphics hang perfectly



Panel Choice  
Comes in traditional curve or  
contemporary flat-wing panels



Free 3-D Rendering  
Includes 3-D display design



Tools-Free Assembly  
Simplifies setup with  
no tools or pros needed

“ We wanted to increase our presence and visibility at the various trade shows and community exhibits we attend throughout the year. This worked out far beyond our expectations! Our visibility blew past all other exhibitors to the point where we regularly receive recognition for our display, and we even won an award for ‘best use of booth space.

”

Steve Gay  
Bank of Southside Virginia



**ISOframe**<sup>®</sup>  
*isobar*

## ISOframe ISObar. Modern, practical, striking.

When you need a stable, eye-catching work surface, ISObar is your best friend. Our modular and freestanding counters come in a variety of shapes and sizes — and they’re available off-the-shelf. They pack flat, assemble without tools and adjust to any size you need.

Choose curved, straight or combination styles. Accessorize your counter with shelves and doors for storage, iPad holders and more. Illuminate your graphics with ISObar’s internal LED lights.

No matter what style and design you select, ISObar transforms a boring counter into a glowing attraction to showcase your brand.



## ISObar Modular Counters: Tools-Free Assembly in Five Quick Steps



1) Clamp posts into base plate.



2) Attach straight or curved extensions.



3) Clamp the top to the top of the posts.



4) Add your accessories.



5) Wrap your magnetic graphics.

## ISObar Freestanding Counters: Tools-Free Assembly in Three Quick Steps



1) Clamp posts into base plate.



2) Clamp top to the posts.



3) Wrap your magnetic graphics.



Multiple Freestanding shapes are available.

## Key Features



Sturdy Construction  
Supports up to 165 lbs



Striking Illumination  
Lights up with optional LEDs



Flexible Layout  
Offers curved, straight and combination shapes



Featured Accessories  
Supports shelves, iPad holders and more



Portable Design  
Ships through UPS or FedEx



Free 3-D Rendering  
Includes 3-D display design



Tools-Free Assembly  
Simplifies setup with no tools or pros needed



## ISOframe Lightboxes. Bright, engaging, versatile.

Grab your audience's attention with the impressive look of backlit fabric. Our Lightboxes give your stand greater visibility and increased visitor interaction. They're especially popular in retail, fashion and exhibitions.

Use them as a part of your stand, a wall mount or a freestanding feature. Tailor them to fit your unique space and design.

Lightboxes are infinitely adaptable — and they're sure to get you noticed.

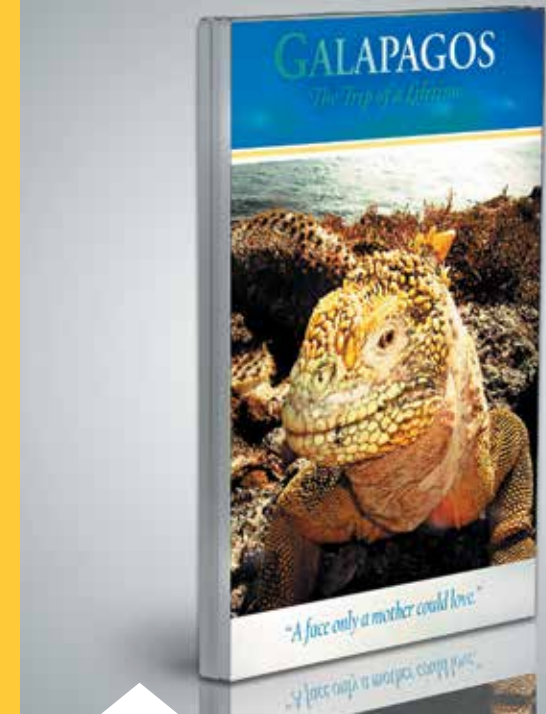

Attract your audience with glowing, gorgeous fabric.



Enhance your presence with the high-impact LED lights.



# When creating world-class displays, ISOframe is just the beginning.

At Mark Bric, we're proud to design, print and build a wide range of exhibit displays to meet your goals, designs and budget. Retail, tradeshow, roadshow and beyond. We get your message across!

Discover the Complete Line of Mark Bric Products at [MarkBricDisplay.com](http://MarkBricDisplay.com).



Maximize your retail and POP advertising.

Banner stands up to 10 feet high and any width.

Set up your step and repeat wall in only two minutes. Choose the world's best retractable banner stand.

# ISOframe COMPARE FEATURES

Which ISOframe is right for you?	<i>Ripple</i>	<i>Wave</i>	<i>Wave Premium</i>	<i>Fabric</i>	<i>Express</i>	<i>ISObar</i>	<i>Light-boxes</i>
Simple to build yourself	•	•		•	•	•	•
Pro-build available		•	•	•		•	•
Tools-free assembly	•	•	•	•	•	•	•
Ships UPS or FedEx	•	•		•	•	•	•
Compatible with all ISOframe systems	•	•	•	•			•
Holds HDTV screens	•	•	•	•	•		
Holds tables		•	•		•		
Holds shelving		•	•			Included	
Bends to any shape	•	•					
Reconfigures in an instant	•	•				•	
Can include private rooms		•	•	•			
Graphics align instantly	•	•	•		•	•	
Lightweight graphic				•			•

“Wow!” That’s the response we most often hear when people see an ISOframe trade show exhibit in person for the first time. With seamless graphics and incredibly flexible designs, swooning over an exhibit is easy. But go beyond the surface, and ISOframe offers even more to love.

Don't create alone. Experience **Exhibit Launch**.



Develop a compelling display with hands-on guidance from our Exhibit Launch Support Team.

Our complimentary Exhibit Launch process makes creating a powerful expo display simple and satisfying. We offer fully streamlined exhibition service — from design to delivery — with our in-house support guiding you through every step in the process.



## State-of-the-art Printing

See your images in exquisite detail on a wide variety of surfaces with our state-of-the-art printing.

**Free exhibit consultations** to select the ISOframe display and design that best bring your brand to life.

**Free 3-D rendering** of your design, so you can see your trade show booth from all angles before we build it.

**Free training available at our Virginia showroom.** Or contact us about sending a representative to train your exhibition team.

**Free pre-build and custom instructions** to ensure your design is perfect when it leaves our hands — and simple to assemble when it's in yours.

**Start your no obligation Exhibit Launch today.**

Call: 800-742-6275  
or visit our Virginia Showroom.  
Email: [markbric@markbric.com](mailto:markbric@markbric.com)



**ISOframe**<sup>®</sup>  
Intelligent Exhibiting™

self-build solutions

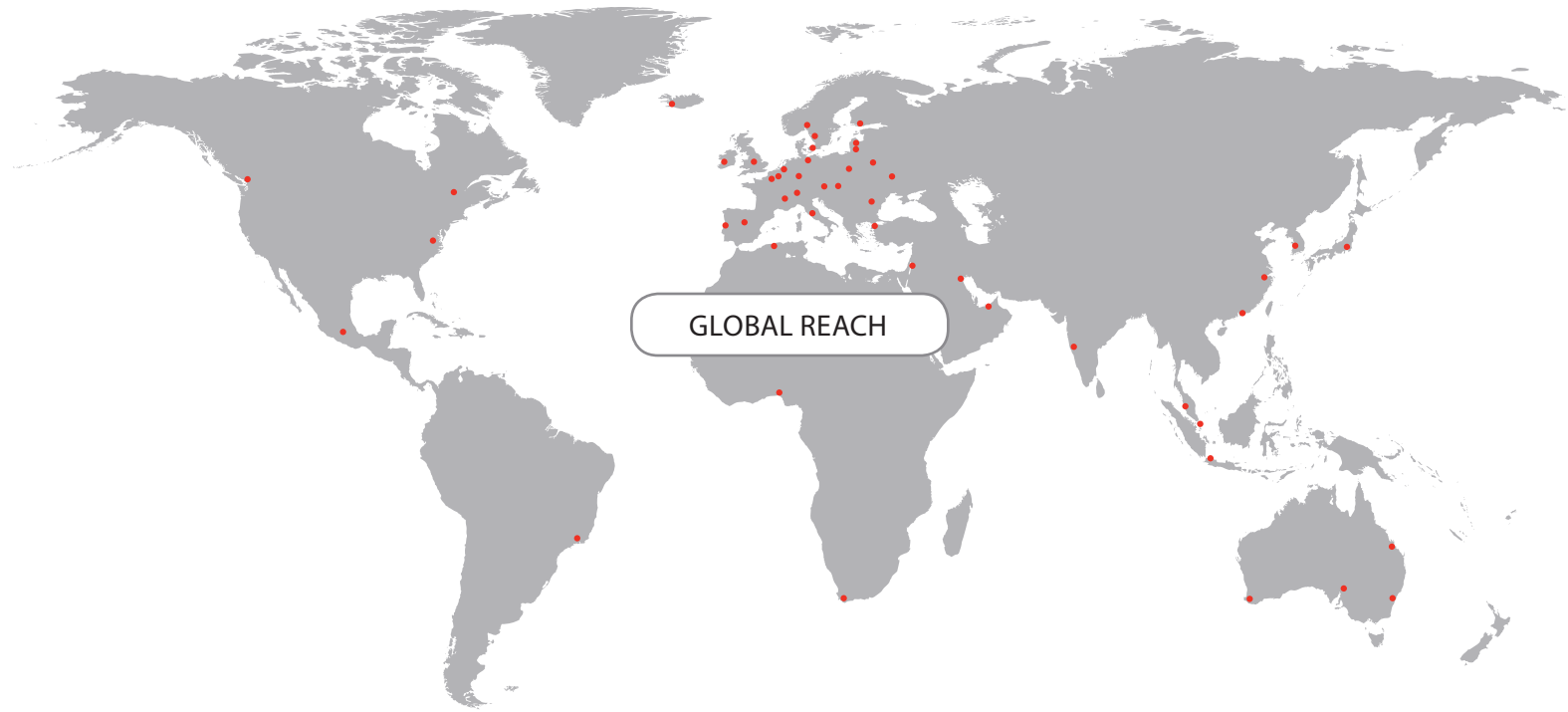

800.742.6275



markbric@markbric.com



ISOframeExhibits.com

MARK BRIC DISPLAY CORPORATION 4740 CHUDOBA PARKWAY PRINCE GEORGE, VA 23875 U.S.A.

©2015 MARK BRIC DISPLAY CORPORATION, ALL RIGHTS RESERVED

**ISOframe**<sup>®</sup>  
ripple

**ISOframe**<sup>®</sup>  
wave

**ISOframe**<sup>®</sup>  
fabric

**ISOframe**<sup>®</sup>  
express

**ISOframe**<sup>®</sup>  
wave premium

**ISOframe**<sup>®</sup>  
isobar

**ISOframe**<sup>®</sup>  
lightboxes